

DUOVENT® COMPACT DV



ErP conform



Digireg®



VAV-CAV-COP control types



max. recuperation efficiency



EC-motor



Bypass

Technical Parameters

■ Casing

Patented ISOSTREAM® Cabinet built out of aluminum profiles to which individual panels are attached by screws. The panels are made out of galvanized sheet metal providing for wall thickness of 45 mm. Finished with external grey-white paint, type RAL9002. The panels are lined with non-flammable mineral wool core and sandwiched from both sides. All panels are fully removable, selected panels are equipped with hinges and locks and providing easy service access. Optional anti-corrosion surface protection is available upon request. In location where condensation will accumulate cabinets are fitted with condensate drains outlets.

■ Fans

Centrifugal backward-curve blades with impeller made out of composite materials. Each fan comes statically and dynamically balanced.

■ Motors

EC motor mounted directly to fan impeller. The fan motor can be continuously controlled by external 0...10V signal. Each motor is fitted with its own integrated thermal protection. Motor efficiency rating is class IE4, electric motor insulation protection is rated IP54.

■ Heat Exchanger

A cross-flow heat exchanger made out of aluminium plates designed to exchange thermal energy from one air stream to another. Heat exchanger's air intake is equipped with a by-pass damper. Mixing damper and recirculation damper can be added per request (marked as C or MX).

■ Filters

Unit's outside air and return air inlets come fitted with either two sets of 48mm compact filter brackets or one set of 96mm filter bracket. Filters classification G4 to F9 is available. Filter access is provided through a set of removable or hinged service doors.

■ Dampers

Aluminum control dampers are mounted on side of outside air inlet and return air inlet. Dampers are installed with Belimo actuators and comply with class 2 leakage rate, EN1751. Optional class 3 leakage rate is available upon request.

■ Heating and Cooling provisions

Based on project requirements each unit can be fitted with either hot water coil or electric heat strip to provide heating and with either chilled water coil or DX coil to provide cooling. Heat pump system can provide primary source of heating or cooling. Coils are built out of copper tubes and aluminum sheets locked inside a galvanized frame. Optional coil anti-corrosion coating is available upon request. Electric heat strip comes equipped with a safety thermostat activating at temperature 60°C and emergency thermostat with manual reset and activating at temperature of 120°C.

■ Power Supply

3x 400V/50Hz or 1x 230V/50Hz. Power cable and control wires penetrates the unit through plastic panel mounted on side of the unit. Pre-drilled holes with rubber penetration gromets provide for running cables on inside of the unit.

■ Controls

In the standard configuration each unit is equipped with either Minireg or Digireg® control system installed inside metal enclosure. The enclosure comes mounted to the unit's mid panel with all internal wiring completed and Digireg control board preprogrammed according to the unit's configuration. Nonstandard enclosure mounting location can be done upon request. QC running test is performed before each unit leaves the manufacturing plant.

■ Installation

Can be installed in vertical position (marked as xV) or in horizontal position (marked

as xH), mounted either under a ceiling or sitting on a floor (marked as xP). Unit's inlet and outlet openings must be put in consideration when ordering and installing unit. Consideration must be placed on any future service access. Adequate space below the unit must be maintained in order to connect condensate drain and to install drain traps. Condensate drain needs to slope at 5 degrees towards the condensate discharge. Round ductwork connects to Duovent DV 500–1200. Rectangular ductwork connects to Duovent DV 1800–7800. Flexible pipe connections and flexible duct connections are recommended in order to eliminate any vibrations coming from the unit. For under the ceiling configuration each unit comes equipped with set of mounting brackets.

■ Noise

Noise data listed in associated acoustic tables represent acoustic output levels at individual inlets or outlets, including tolerance for weight filter A. The table includes acoustic noise level incorporating casing of the unit and reads noise level when measured 1 m from the service side of the unit, in open field Q=2. The acoustic readings come within ±3dB tolerance.

■ Unit Configuration

Unit's initial configuration and unit's accessories are identified by a specific code which is encoded into model number. Any non-typical, custom configuration needs to be consulted prior to ordering of the unit.

■ Warranty Terms

DUOVENT® COMPACT DV equipment, incl. DVAV, DCAV, DCOP and MVAV systems, must be commissioned by factory authorized service technician. Failure to provide factory authorized commissioning will lead to termination of the rights of the Buyer and will void unit's warranty.

Ductwork Accessories

- **SPIRO** round pipe and fittings (K7.3)
- **IAE** flexible couplings (K7.1)
- **IAA** noise attenuators (K7.1)
- **TSK** dampers (K7.1)
- **MSK, IJK** adjustable throttle and mixing dampers (K7.1)
- Disc valves, diffusers, orifices, grilles (K7.2)
- Rain louvres (K7.1)

Controls Accessories

- **Digireg®** digital control system for units equipped with heating and cooling, controller with touch-screen display (K9)
- **JTR** triac switch for electric heater control (K9)
- **HIG, HYG** hygrostats (K8.2)
- **AIRSENS, EDF-CO2, SQA** sensors CO2 (K8.2)
- **RTR** thermostats (K8.2)

- **DTS PSA** pressure sensors (K8.2)
- **Servo-drives** (K8.2)

Model Number Abbreviation List

D	U	O	E	N	T	C	O	M	P	A	C	T	D	V	5	0	0	D	C	A	D	C	C	M	X	K	L	G	4	/	G	4	M	V	A	V	F	V	S	P		
															1			2			3			4			5			6			7			8			9			10

1 – unit size – 500, 800, 1200, 1800, 3000, 4200, 5100, 6000, 7800

2 – type of heating:

DI – electric

DCA – water, temperature gradient 80/60°C

DCB – water, temperature gradient 45/35°C

3 – type of cooling:

DCC – water, temperature gradient 6/12°C

DX – direct evaporation coil, R410A or R32 refrigerant, evaporation temperature 6°C

(When using DX coil we must specify type of refrigerant, cooling capacity and amount of cooling circuits based on type of condensing unit being used)

DXr – direct evaporation cooling coil use for heating and cooling, R410A or R32 refrigerant

4 – **MX** – mixing air damper, without actuator (when unit is ordered with Digireg MAR system, the power actuator becomes part of delivery)

C – mixing air damper designed for 100% air recirculation (when unit is ordered with Digireg MAR system, the power actuator becomes part of delivery)

5 – **KL** – outside air and return air dampers, without actuators (when unit is ordered with Digireg MAR system, the power actuator becomes part of delivery)

6 – classification of air filters for outside air and return air inlets (G4–F9)

7 – type of unit control system:

D – Digireg®

M – Minireg

8 – type of airflow regulation:

VAV – variable air volume

CAV – constant air volume

COP – constant operating pressure

9 – placement of unit's inlets and outlets

10 – **SP** – setup for a swimming pool ventilation, this configuration needs to be consulted with our technical team prior to ordering

Class acc. to EN779	Class acc. to EN ISO 16890
G4	ISO Coarse 60%
M5	ISO ePM10 50%
F7	ISO ePM2,5 70%
F9	ISO ePM1 80%

Order examples

DUOVENT® COMPACT DV 3000 DI DX MX KL G4+F7/F7 DVAV JH2

Unit size 3000, equipped with electric heater, direct evaporation coil for cooling, mixing damper, double filter brackets on the supply side with filter grade G4+F7, single filter bracket on the exhaust side with filter grade F7, Digireg MAR system with VAV configuration, JH2 inlet/outlet configuration.

Recuperation

Supplementing figures

Air flow direction in DUOVENT® COMPACT DV units:

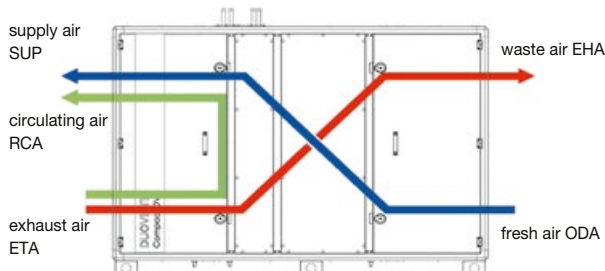

DUOVENT® COMPACT DV



Recuperation

Type	Nominal flow [m³/h]	voltage [V/Hz]	Inlet/exhaust fan		heater		cooler power* [kW]	efficiency* [%]	unit max. air flow** [m³/h]	control system	weight*** [kg]
			max. input power [W]	current [A]	power* [kW]	current [A]					
500	450	1×230V 50 Hz	180/127	0.8/0.6	-	-	-	89.8	550	M1-Vx	91-103
500 DCA					2.9	-	-				
500 DCB					2.1	-	-				
500 DCA DCC					2.9	-	2				
500 DCA DX					2.9	-	2.8				
500 DI					2	8.7	-		M1-E8-2		
800	720	1×230V 50 Hz	326/235	1.4/1.0	-	-	-	90	900	M1-Vx	136-153
800 DCA					4.7	-	-				
800 DCB					3.1	-	-				
800 DCA DCC					4.7	-	3				
800 DCA DX					4.7	-	4.3				
800 DI					3.6	16	-		M1-E8-2		
1200	1200	1×230V 50 Hz	489/431	2.1/1.9	-	-	-	90.4	1400	M1-Vx	187-214
1200 DCA					8.3	-	-				
1200 DCB					5.3	-	-				
1200 DCA DCC					8.3	-	5.4				
1200 DCA DX					8.3	-	7.8				
1200 DI					3.6	16	-		M1-E8-2		
1800	1800	3×400V 50 Hz	669/505	2.9/2.2	-	-	-	89.5	2000	M3-Vx	274-326
1800 DCA					13.1	-	-				
1800 DCB					8.4	-	-				
1800 DCA DCC					13.1	-	12.4				
1800 DCA DX					13.1	-	12.7				
1800 DI					7.5	10.8	-		M3-E8-2		
3000	3000	3×400V 50 Hz	1238/927	1.8/1.4	-	-	-	89.1	3500	M3-Vx	320-387
3000 DCA					21.8	-	-				
3000 DCB					14.5	-	-				
3000 DCA DCC					21.8	-	21.3				
3000 DCA DX					21.8	-	21				
3000 DI					15	22	-		M3-E15		
4200	4200	3×400V 50 Hz	1636/1297	2.4/1.9	-	-	-	90.6	4500	M3-Vx	373-457
4200 DCA					29.8	-	-				
4200 DCB					20.5	-	-				
4200 DCA DCC					29.8	-	30.2				
4200 DCA DX					29.8	-	30.4				
4200 DI					15	22	-		M3-E15		
5100	5100	3×400V 50 Hz	1925/1544	2.8/2.2	-	-	-	90.5	5500	M3-Vx	420-521
5100 DCA					37.7	-	-				
5100 DCB					24.4	-	-				
5100 DCA DCC					37.7	-	37.3				
5100 DCA DX					37.7	-	36.6				
5100 DI					22.5	33	-		M3-E24		
6000	6000	3×400V 50 Hz	2327/1933	3.4/2.8	-	-	-	90.6	6500	M3-Vx	458-574
6000 DCA					44.6	-	-				
6000 DCB					29.5	-	-				
6000 DCA DCC					44.6	-	45.8				
6000 DCA DX					44.6	-	44.7				
6000 DI					22.5	33	-		M3-E24		
6900	6600	3×400V 50 Hz	2567/2210	3.7/3.2	-	-	-	90.6	7000	M3-Vx	505-636
6900 DCA					51.2	-	-				
6900 DCB					33.9	-	-				
6900 DCA DCC					51.2	-	50.1				
6900 DCA DX					51.2	-	48.9				
6900 DI					30	43.5	-		M3-E36		
7800	7300	3×400V 50 Hz	2633/2270	3.8/3.3	-	-	-	90.8	8000	M3-Vx	547-693
7800 DCA					56.5	-	-				
7800 DCB					38.5	-	-				
7800 DCA DCC					56.5	-	53.6				
7800 DCA DX					56.5	43.5	57				
7800 DI					30	43.3	-		M3-E36		

* at nominal air flow, t_i = 12°C/90 % r.h., t_e = 22°C / 50% r.h., t_e = 35°C/35 % r.h. (SUMMER)

** for arrangement – inlet: filter F7+DV+DCB, outlet: filter M5+DV

*** in relation to the unit accessory (without I&C)

Water cooler power DCC for t_e = 35°C/35 % r.h., t_w = 6/12°C. Water heater power DCA for t_e = 10°C, t_w = 80/60°C.

Water heater power DCB for t_e = 10°C, t_w = 45/35°C. Direct evaporating unit power DX for R410A coolant, t_e = 35°C/35 % r.h., t_{evp} = 6°C.

DUOVENT® COMPACT DV

DUOVENT® COMPACT DV 500 to 1200, floor arrangement (positions „xP“, AP unit position drawn)

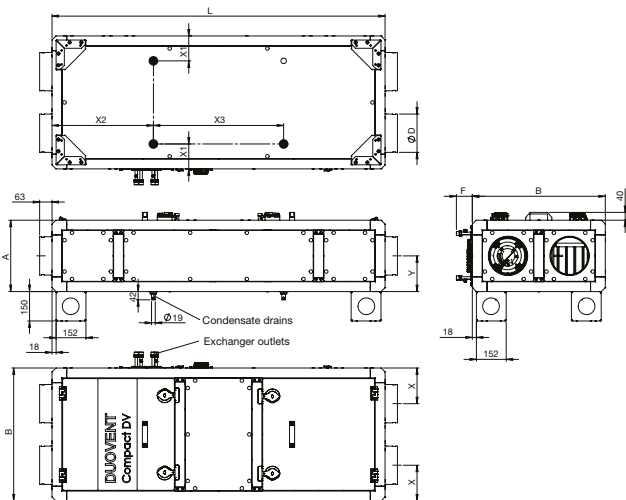

Type	A [mm]	B [mm]	Ø D [mm]	F [mm]	L [mm]	X [mm]	Y [mm]	X1 [mm]	X2 [mm]	X3 [mm]
DUOVENT DV 500	364	678	197	80	1698	182	182	127	517	664
DUOVENT DV 800	364	992	247	80	1934	230	182	127	474	887
DUOVENT DV 1200	521	992	312	80	2091	260.5	260.5	127	523	1045

DUOVENT® COMPACT DV 1800 to 7800, vertical arrangement (positions „xV“, AV unit position drawn)

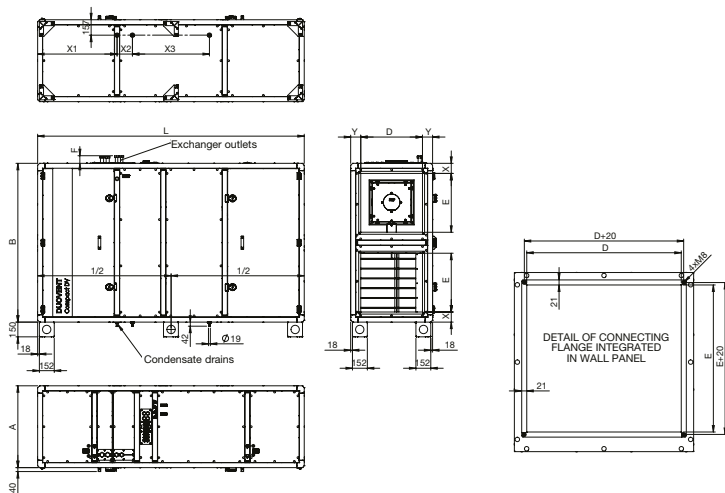

Type	A [mm]	B [mm]	D [mm]	E [mm]	F [mm]	L [mm]	X [mm]	Y [mm]	X1 [mm]	X2 [mm]	X3 [mm]
DUOVENT DV 1800	521	1620	300	600	70	2562	103	110.5	810	157	708
DUOVENT DV 3000	678	1620	450	600	70	2562	103	114	810	157	708
DUOVENT DV 4200	835	1620	630	600	70	2719	103	102.5	810	157	785
DUOVENT DV 5100	992	1620	800	600	70	2719	103	96	810	157	785
DUOVENT DV 6000	1149	1620	950	600	70	2719	103	99.5	810	157	785
DUOVENT DV 6900	1306	1620	1100	600	70	2719	103	103	810	157	785
DUOVENT DV 7800	1463	1620	1250	600	70	2719	103	106.5	810	157	785

DUOVENT® COMPACT DV 1800 to 7800, under-ceiling arrangement (positions „xH“, AH unit position drawn)

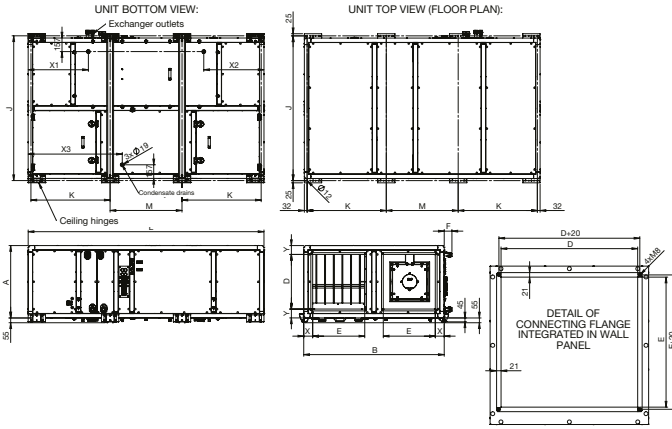

Type	A [mm]	B [mm]	D [mm]	E [mm]	F [mm]	J [mm]	K [mm]	L [mm]	M [mm]	X [mm]	Y [mm]	X1 [mm]	X2 [mm]	X3 [mm]
DUOVENT DV 1800	521	1620	300	600	90	1670	966	2562	566	103	110.5	627	627	1085
DUOVENT DV 3000	678	1620	450	600	90	1670	966	2562	566	103	114	627	627	1085
DUOVENT DV 4200	835	1620	630	600	90	1670	913	2719	829	103	102.5	694	694	1085
DUOVENT DV 5100	992	1620	800	600	90	1670	913	2719	829	103	96	694	694	1085
DUOVENT DV 6000	1149	1620	950	600	90	1670	913	2719	829	103	99.5	694	694	1085
DUOVENT DV 6900	1306	1620	1100	600	90	1670	913	2719	829	103	103	694	694	1085
DUOVENT DV 7800	1463	1620	1250	600	90	1670	913	2719	829	103	106.5	694	694	1085

DUOVENT® COMPACT DV 1800 to 7800, floor arrangement (positions „xP“, AP unit position drawn)

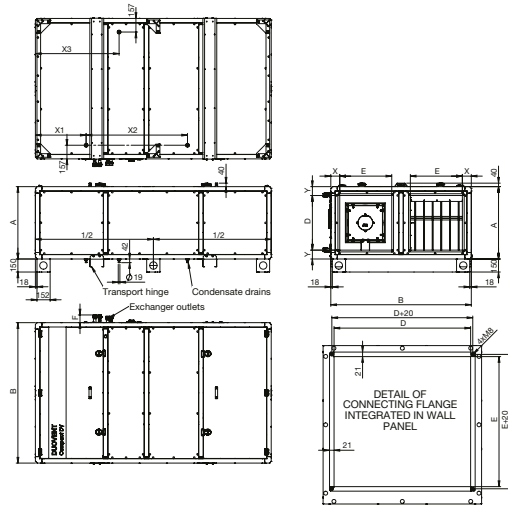

Type	A [mm]	B [mm]	D [mm]	E [mm]	F [mm]	L [mm]	X [mm]	Y [mm]	X1 [mm]	X2 [mm]	X3 [mm]
DUOVENT DV 1800	521	1620	300	600	90	2562	103	110.5	650	1261	650
DUOVENT DV 3000	678	1620	450	600	90	2562	103	114	650	1261	650
DUOVENT DV 4200	835	1620	630	600	90	2719	103	102.5	585	1169	965
DUOVENT DV 5100	992	1620	800	600	90	2719	103	96	585	1169	965
DUOVENT DV 6000	1149	1620	950	600	90	2719	103	99.5	585	1169	965
DUOVENT DV 6900	1306	1620	1100	600	90	2719	103	103	585	1169	965
DUOVENT DV 7800	1463	1620	1250	600	90	2719	103	106.5	585	1169	965

DUOVENT® COMPACT DV

Dimensions of outlet necks of DUOVENT® COMPACT DV 1800–7800 units with side outlets (AV unit position drawn). The below shown diagram applies to all unit outlets of the supply air (SUP) or waste air (EHA) facing the side, resp. upper side of the unit. For all positions (vertical V i V2, floor P i P2, under-ceiling H i H2) there are following combinations of the neck arrangement: B, C, E, F, G, H, J, K, M, N, O, P

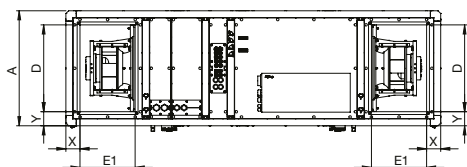
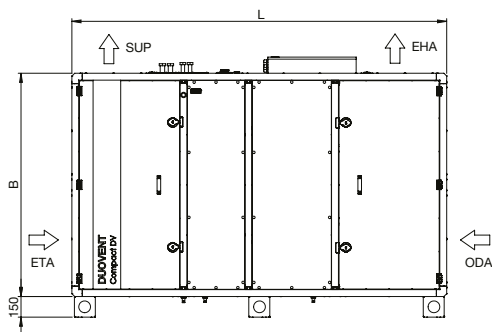

Size unit	E1 [mm]
DUOVENT DV 1800–3000	350
DUOVENT DV 4200–7800	400

Supplementing figures – installation examples of DUOVENT® COMPACT DV



DUOVENT® COMPACT DV 500 to 1200
– under-ceiling variant



DUOVENT® COMPACT DV 500 to 1200
– floor variant



DUOVENT® COMPACT DV 500 to 1200
– vertical variant



DUOVENT® COMPACT DV 1800 to 7800
– under-ceiling variant



DUOVENT® COMPACT DV 1800 to 7800
– floor variant



DUOVENT® COMPACT DV 1800 to 7800
– vertical variant

Minimum service space of DUOVENT® COMPACT DV

Size	A [mm]	B [mm]	L [mm]	P [mm]	R [mm]	S [mm]
500	364	678	1698	1280	1200	800
800	364	992	1934	1600	1200	800
1200	521	992	2091	1600	1400	800
1800	521	1620	2562	2250	1500	800
3000	678	1620	2562	2250	1650	800
4200	835	1620	2719	2250	1800	800
5100	992	1620	2719	2250	2000	1100
6000	1149	1620	2719	2250	2200	1300
6900	1306	1620	2719	2250	2400	1450
7800	1463	1620	2719	2250	2600	1600

Under-ceiling variant – positions „xH“

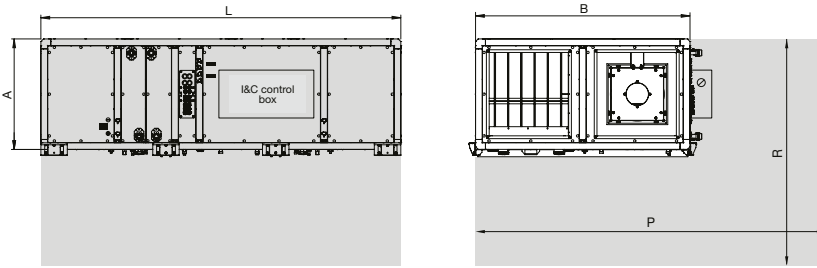

Floor variant – positions „xP“

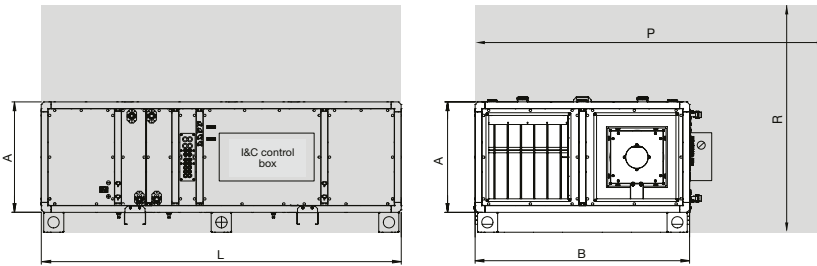

Vertical variant – positions „xV“

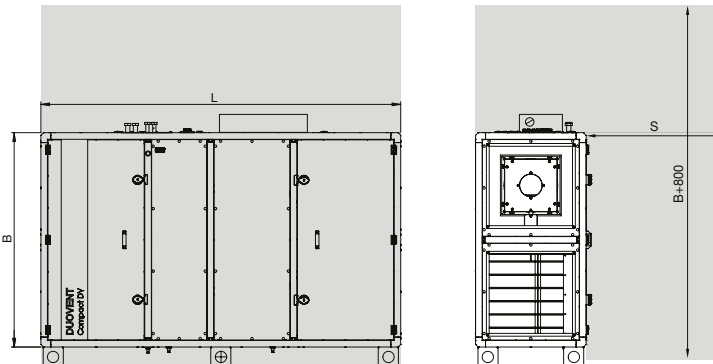

Characteristics

- Q air flow (m³/h)
 - Δp_{st} external static pressure (Pa)
 - P fan electric input (W)
 - heat recuperation efficiency (%)
- F7+DV+DCB+DCC performance curve with maximum pressure loss of inner parts at inlet side (i.e. F7 filter at inlet, recuperator, 3 rows water heaters, 4 rows water cooler, drop eliminator)

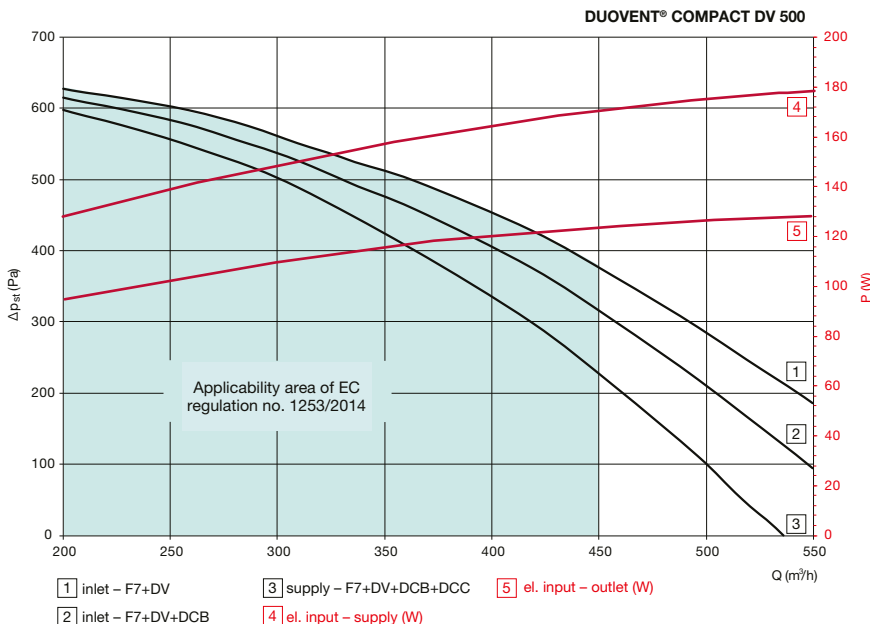

- 1 inlet - F7+DV
- 2 inlet - F7+DV+DCB
- 3 supply - F7+DV+DCB+DCC
- 4 el. input - supply (W)
- 5 el. input - outlet (W)

DUOVENT® COMPACT DV 500 – recuperation efficiency

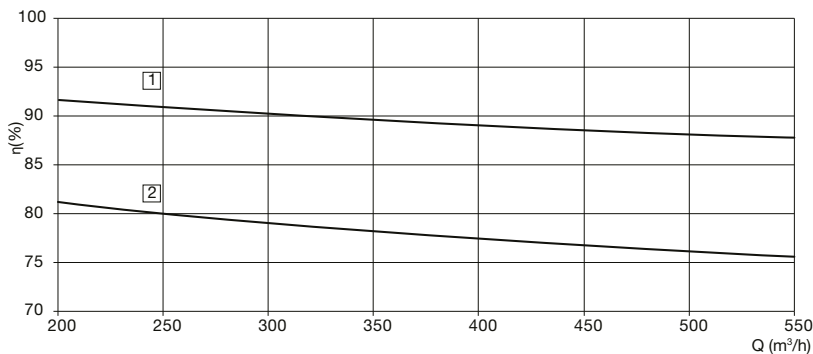

- 1 Efficiency for parameters:
EXHAUST: 22°C/50% r.h.
SUPPLY: -12°C/90% r.h.
- 2 Efficiency acc. to EC/1253/2014

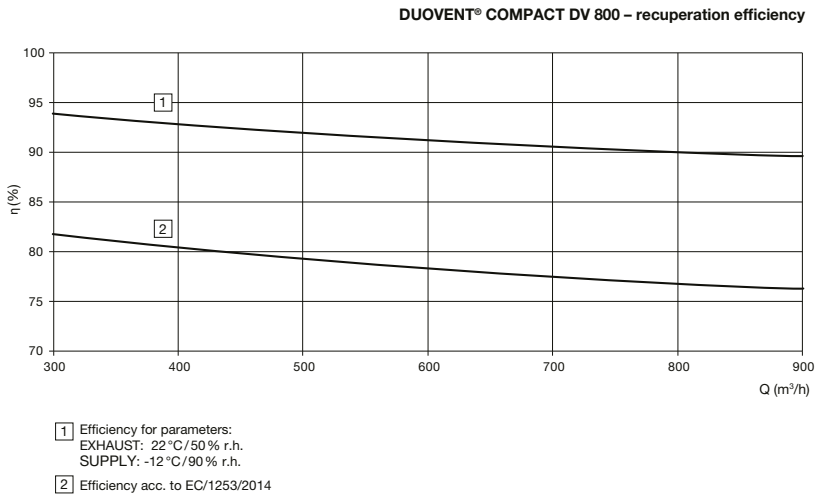
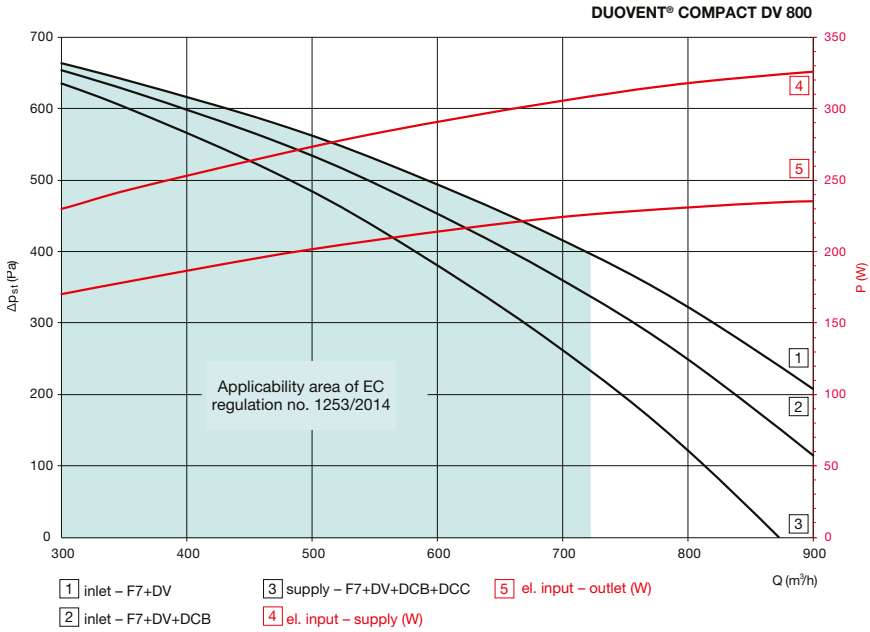

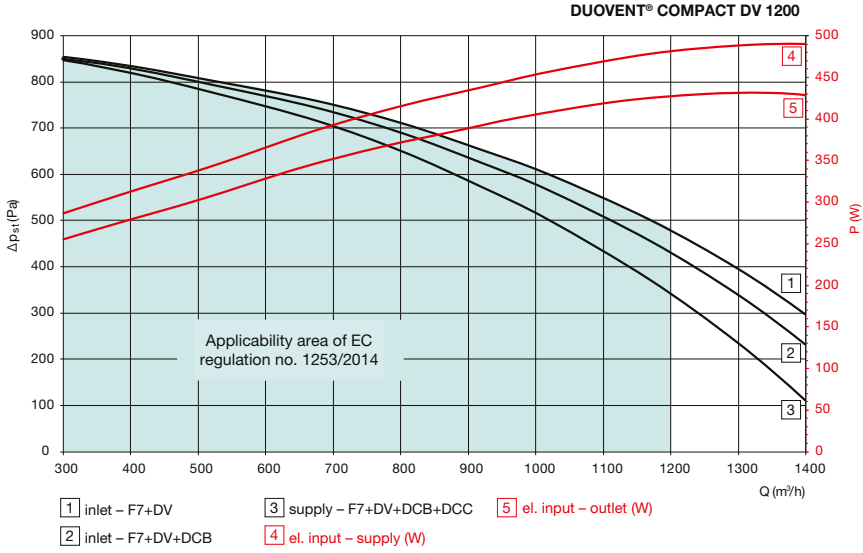

Recuperation

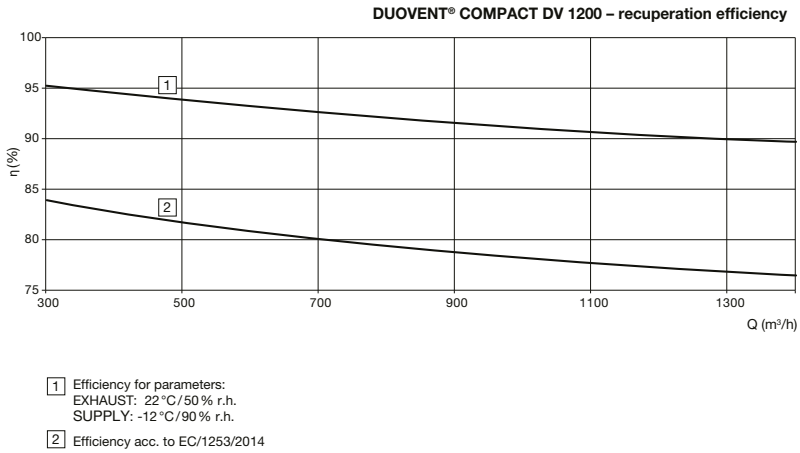

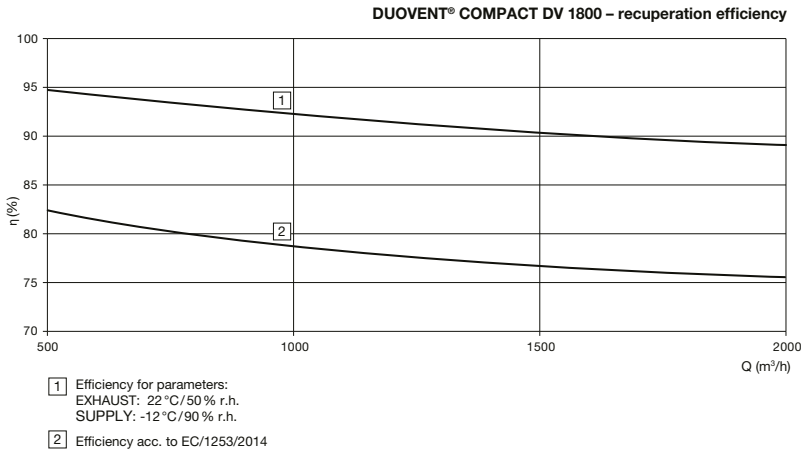
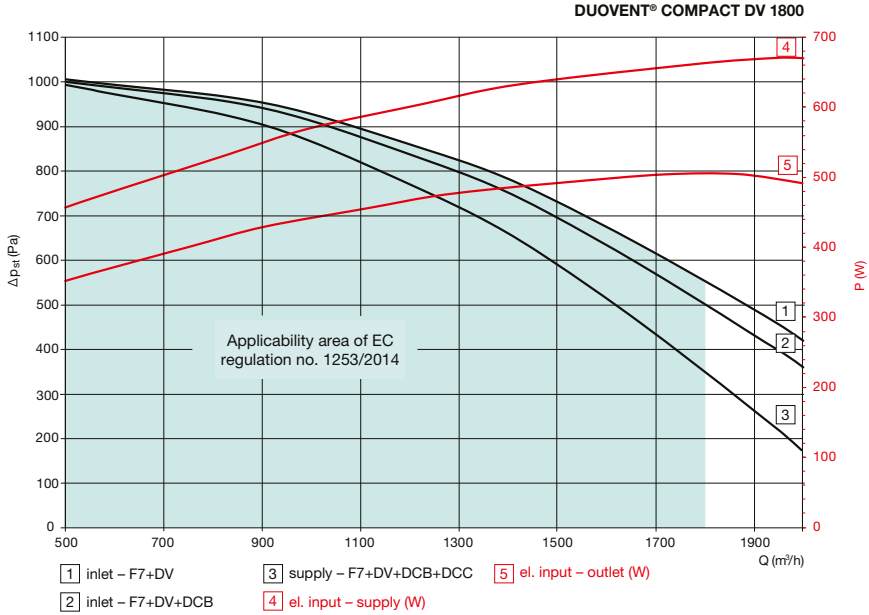

DUOVENT® COMPACT DV

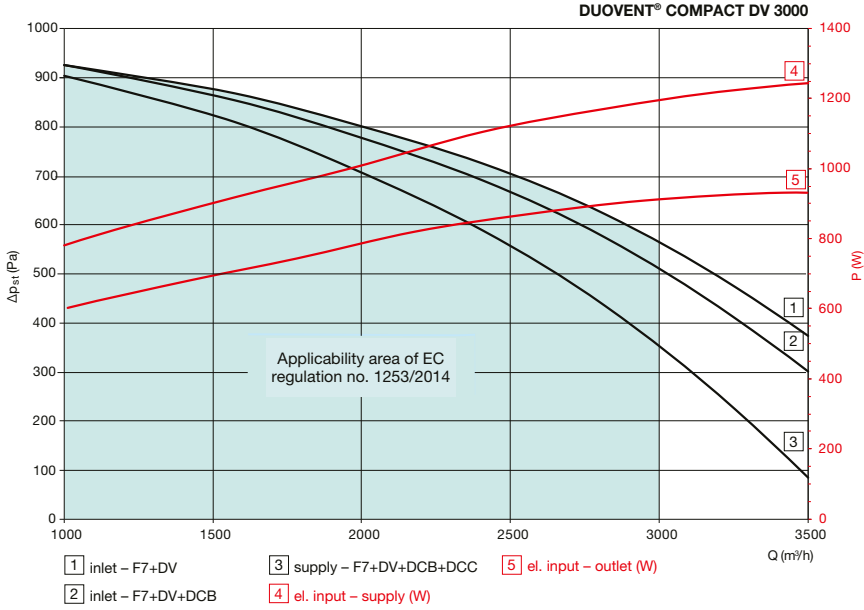

Recuperation

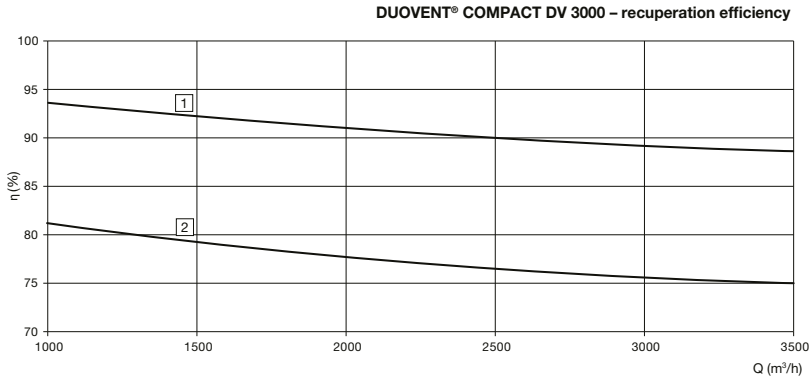

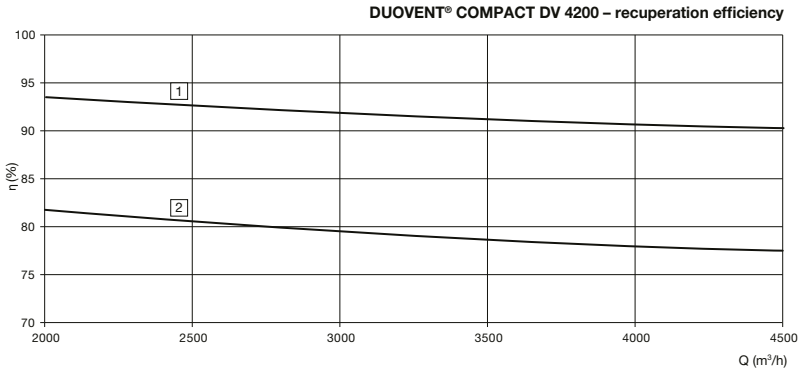
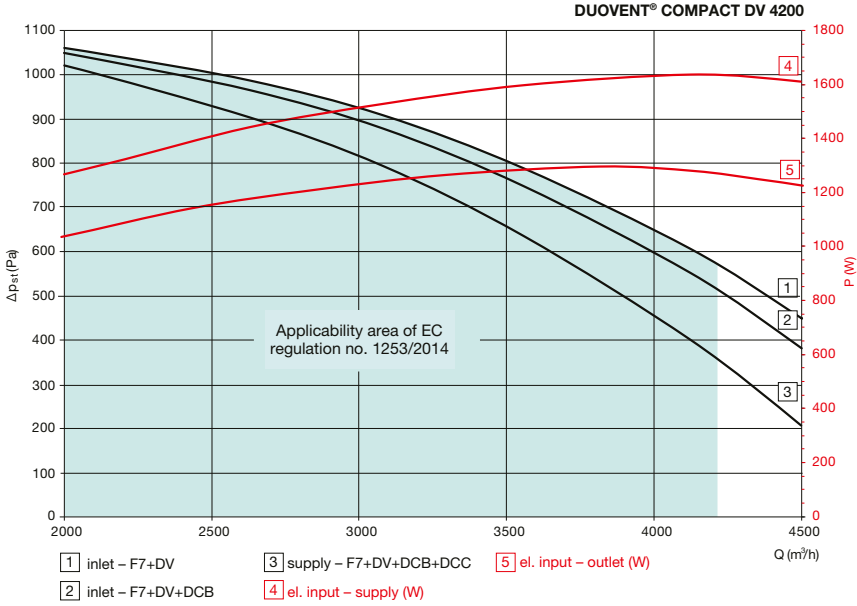

- 1 Efficiency for parameters:
EXHAUST: 22°C/50% r.h.
SUPPLY: -12°C/90% r.h.
- 2 Efficiency acc. to EC/1253/2014

DUOVENT® COMPACT DV 5100

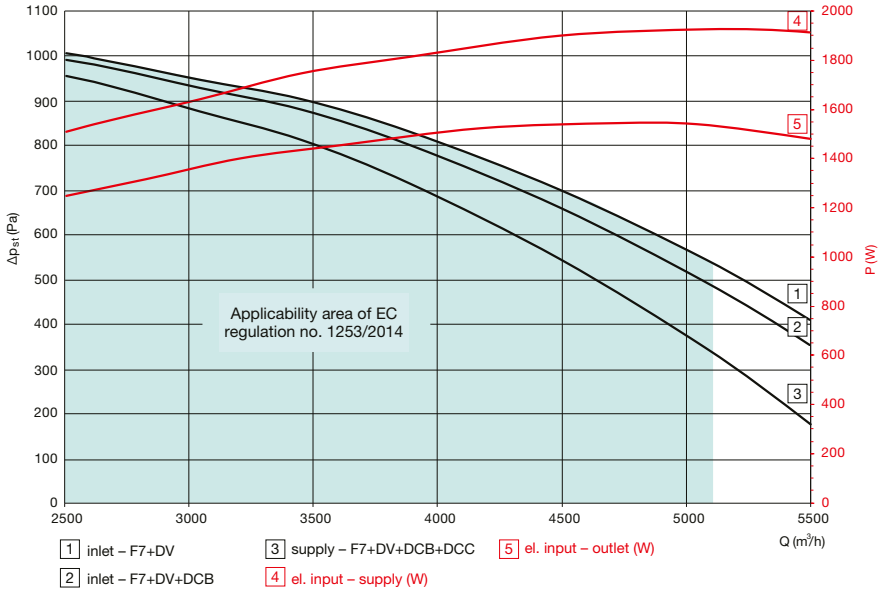

DUOVENT® COMPACT DV 5100 - recuperation efficiency

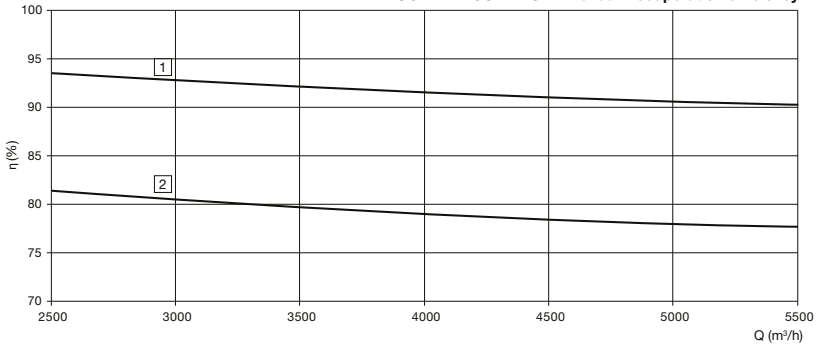

- 1 Efficiency for parameters:
EXHAUST: 22°C/50% r.h.
SUPPLY: -12°C/90% r.h.
- 2 Efficiency acc. to EC/1253/2014

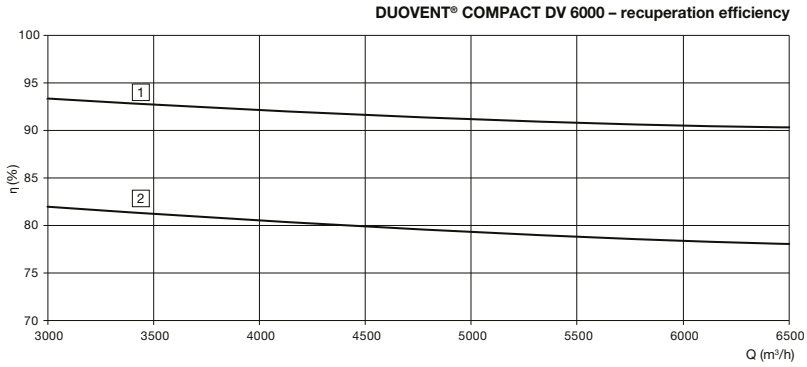
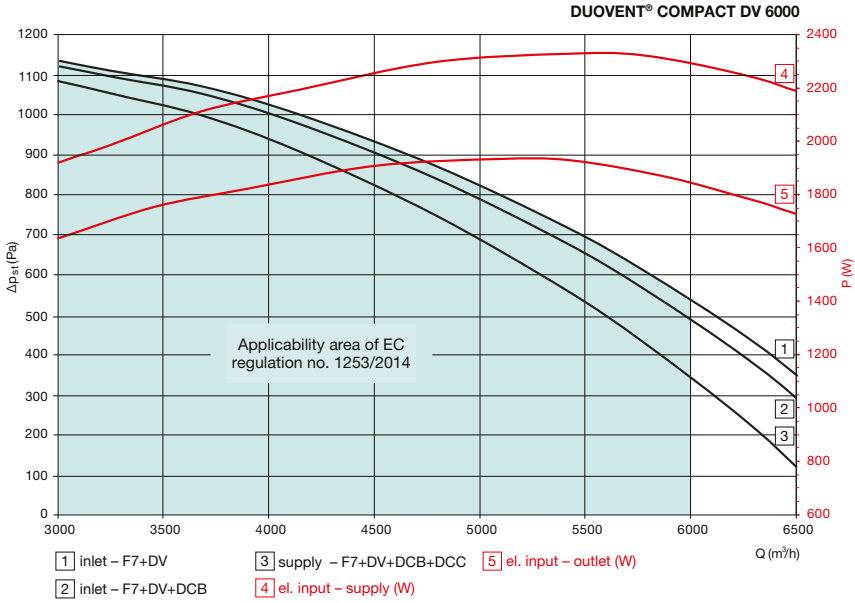

- 1 Efficiency for parameters:
EXHAUST: 22°C/50% r.h.
SUPPLY: -12°C/90% r.h.
- 2 Efficiency acc. to EC/1253/2014

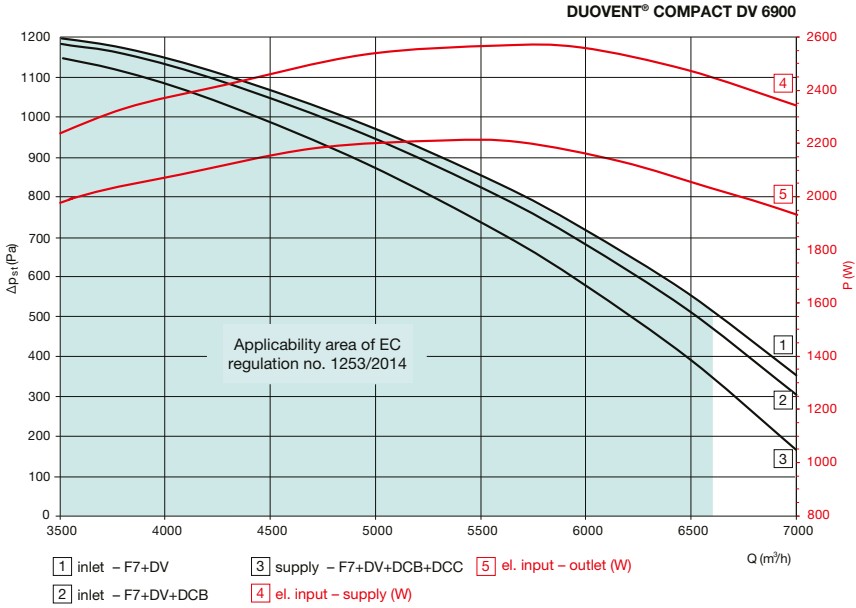

Recuperation

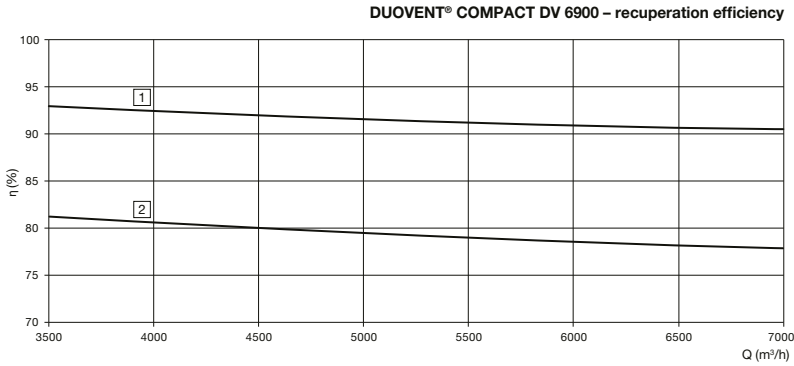

- 1 Efficiency for parameters:
EXHAUST: 22°C/50% r.h.
SUPPLY: -12°C/90% r.h.
- 2 Efficiency acc. to EC/1253/2014

DUOVENT® COMPACT DV 7800

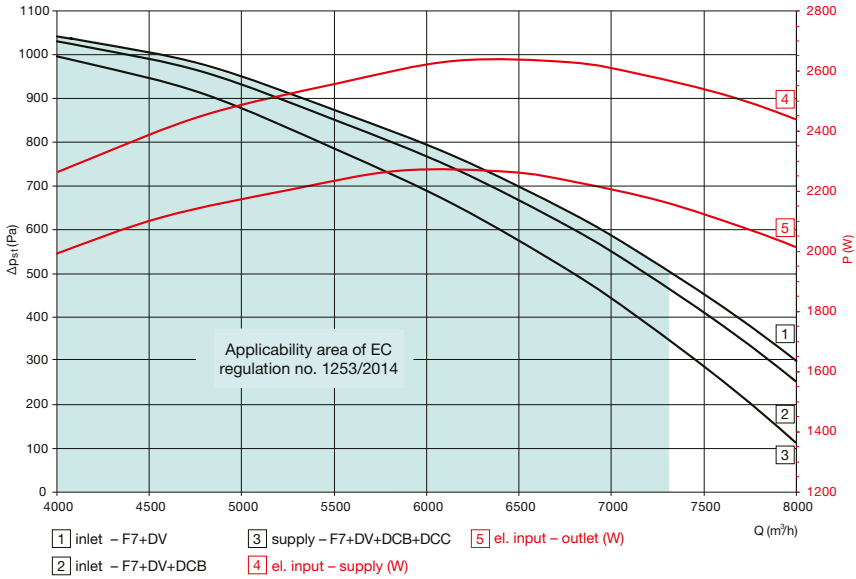

DUOVENT® COMPACT DV 7800 - recuperation efficiency

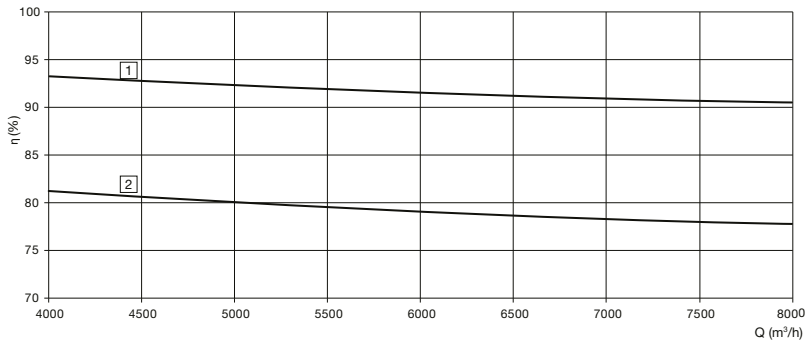

- 1 Efficiency for parameters:
EXHAUST: 22°C/50% r.h.
SUPPLY: -12°C/90% r.h.
- 2 Efficiency acc. to EC/1253/2014

DUOVENT® COMPACT DV

Acoustic power (pressure) level in octave ranges [dB(A)]*

DUOVENT COMPACT DV 500 (for $V_{nom} = 450 \text{ m}^3/\text{h}$)

Hz	63	125	250	500	1000	2000	4000	8000	L_{WA}
fresh	38	46	52	59	57	56	49	37	63
inlet	42	52	60	68	71	73	66	63	76
L_{WA} exhaust	35	45	52	56	57	56	50	48	62
waste	37	48	57	63	68	70	63	59	73
case**	34	47	53	59	46	42	29	21	56

DUOVENT COMPACT DV 800 (for $V_{nom} = 720 \text{ m}^3/\text{h}$)

Hz	63	125	250	500	1000	2000	4000	8000	L_{WA}
fresh	48	54	60	63	61	54	47	44	67
inlet	48	59	69	72	73	73	65	61	78
L_{WA} exhaust	45	54	58	62	60	53	48	45	66
waste	44	56	64	68	70	70	61	58	75
case**	40	55	62	55	48	42	27	20	63

DUOVENT COMPACT DV 1200 (for $V_{nom} = 1200 \text{ m}^3/\text{h}$)

Hz	63	125	250	500	1000	2000	4000	8000	L_{WA}
fresh	46	52	59	63	64	57	51	48	68
inlet	50	58	72	74	80	76	69	66	83
L_{WA} exhaust	44	52	60	64	64	58	53	50	68
waste	46	55	68	72	77	74	67	64	80
case**	42	54	65	58	55	45	32	25	66

DUOVENT COMPACT DV 1800 (for $V_{nom} = 1800 \text{ m}^3/\text{h}$)

Hz	63	125	250	500	1000	2000	4000	8000	L_{WA}
fresh	41	43	54	61	60	55	50	47	65
inlet	48	52	64	73	76	76	68	65	80
L_{WA} exhaust	39	42	54	61	60	56	52	49	65
waste	43	48	62	69	73	73	66	63	77
case**	40	47	58	56	59	45	31	24	61

DUOVENT COMPACT DV 3000 (for $V_{nom} = 3000 \text{ m}^3/\text{h}$)

Hz	63	125	250	500	1000	2000	4000	8000	L_{WA}
fresh	38	45	61	60	57	58	52	48	66
inlet	47	55	72	73	78	76	70	66	82
L_{WA} exhaust	35	45	59	61	58	58	53	49	65
waste	41	51	67	70	75	74	67	63	79
case**	39	50	65	57	53	45	33	25	66

DUOVENT COMPACT DV 4200 (for $V_{nom} = 4200 \text{ m}^3/\text{h}$)

Hz	63	125	250	500	1000	2000	4000	8000	L_{WA}
fresh	35	42	61	61	57	58	51	50	66
inlet	44	53	71	74	79	78	72	70	83
L_{WA} exhaust	38	45	61	63	59	59	53	54	67
waste	42	52	68	72	78	76	70	68	81
case**	37	50	64	58	55	47	35	29	66

DUOVENT COMPACT DV 5100 (for $V_{nom} = 5100 \text{ m}^3/\text{h}$)

Hz	63	125	250	500	1000	2000	4000	8000	L_{WA}
fresh	37	46	62	62	59	58	51	48	67
inlet	47	56	73	76	80	77	71	67	83
L_{WA} exhaust	38	53	63	64	60	59	53	51	68
waste	45	58	71	75	78	75	69	66	82
case**	40	54	67	60	55	46	34	26	68

DUOVENT COMPACT DV 6000 (for $V_{nom} = 6000 \text{ m}^3/\text{h}$)

Hz	63	125	250	500	1000	2000	4000	8000	L_{WA}
fresh	38	44	65	63	61	60	53	53	69
inlet	48	56	75	77	82	79	73	72	85
L_{WA} exhaust	41	50	66	66	63	62	56	57	71
waste	46	57	74	77	81	78	72	71	84
case**	42	55	70	63	60	50	38	36	72

DUOVENT COMPACT DV 6900 (for $V_{nom} = 6600 \text{ m}^3/\text{h}$)

Hz	63	125	250	500	1000	2000	4000	8000	L_{WA}
fresh	40	46	66	65	62	61	54	58	70
inlet	49	58	76	79	84	80	74	76	87
L_{WA} exhaust	43	50	69	68	65	63	57	62	73
waste	48	58	76	78	83	79	74	76	86
case**	42	55	70	63	60	50	38	36	72

DUOVENT COMPACT DV 7800 (for $V_{nom} = 7300 \text{ m}^3/\text{h}$)

Hz	63	125	250	500	1000	2000	4000	8000	L_{WA}
fresh	51	55	67	67	62	60	52	54	71
inlet	56	64	77	80	83	79	72	72	87
L_{WA} exhaust	53	58	68	70	64	62	55	59	73
waste	55	64	76	80	82	78	71	73	86
case**	49	61	71	65	59	49	36	32	72

* data for unit configuration (Integr. flaps, water cooler DCC, water heater DCA, filtering class F7/M5)

** shell damping with R_w value

Characteristics of recuperation units acc. to EC regulation 2009/125/EC, no. 1253/2014.

Size unit	Nominal air flow [m ³ /h]	SFP _{int} [W/(m ³ /s)]	recuperation efficiency [%]	SFP _{int LIMIT 2018} [W/(m ³ /s)]	external pressure [Pa]
500	450	996	77.5	1216	230
800	720	1158	77.4	1202	250
1200	1200	1023	77.2	1176	350
1800	1800	847	76.1	1118	350
3000	3000	1039	75.6	1053	350
4200	4200	1004	77.9	1072	350
5100	5100	998	77.9	1035	350
6000	6000	1014	78.5	1015	350
6900	6600	970	78.1	978	350
7800	7300	918	78.2	956	350

Technical data of water heaters DCA ($t_w = 80/60^\circ\text{C}$) and DCB ($t_w = 45/35^\circ\text{C}$)

Size unit	temp. gradient [°C]	power [kW]	air flow [m³/h]	air inlet temperature [°C]	air outlet temperature [°C]	pressure loss at water side [kPa]	water flow [m³/h]
500	80/60	2.9	450	10	29.3	2	0.13
	45/35	2.1			23.6	5	0.18
800	80/60	4.7	720	10	29.7	5	0.21
	45/35	3.1			22.9	6	0.27
1200	80/60	8.3	1200	10	30.7	8	0.37
	45/35	5.3			23.1	11	0.46
1800	80/60	13.1	1800	10	31.7	12	0.57
	45/35	8.4			23.9	7	0.73
3000	80/60	21.8	3000	10	31.7	16	0.96
	45/35	14.5			24.5	14	1.26
4200	80/60	29.8	4200	10	31.2	9	1.31
	45/35	20.5			24.6	19	1.78
5100	80/60	37.7	5100	10	32.1	13	1.66
	45/35	24.4			24.3	6	2.12
6000	80/60	44.6	6000	10	32.2	11	1.96
	45/35	29.5			24.7	10	2.56
6900	80/60	51.2	6600	10	33.2	15	2.25
	45/35	33.9			25.3	12	2.94
7800	80/60	56.5	7300	10	33.1	8	2.48
	45/35	38.5			25.7	16	3.34

Technical data of water coolers DCC ($t_w = 6/12^\circ\text{C}$) and evaporation units DX ($t_{sp} = 6^\circ\text{C}$, R410A coolant)

Size unit	temp. gradient/ evaporation temp. [°C]	power [kW]	air flow [m³/h]	inlet temperature rel. humidity [%]	air outlet [°C]	pressure loss at water/ coolant side [kPa]	water flow [m³/h]
500	6/12	2	450	35 °C / 35 %	21.9	13	0.28
	6	2.8			21.3	109	-
800	6/12	3	720	35 °C / 35 %	22.6	6	0.43
	6	4.3			21.5	119	-
1200	6/12	5.4	1200	35 °C / 35 %	21.6	11	0.78
	6	7.8			21.1	96	-
1800	6/12	12.4	1800	35 °C / 35 %	19.3	14	1.78
	6	12.7			19.6	49	-
3000	6/12	21.3	3000	35 °C / 35 %	19.1	20	3.04
	6	21			19.7	99	-
4200	6/12	30.2	4200	35 °C / 35 %	19.1	23	4.31
	6	30.4			19.4	67	-
5100	6/12	37.3	5100	35 °C / 35 %	18.8	21	5.33
	6	36.6			19.4	110	-
6000	6/12	45.8	6000	35 °C / 35 %	18.5	31	6.54
	6	44.7			19	93	-
6900	6/12	50.1	6600	35 °C / 35 %	18.8	40	7.15
	6	48.9			19	123	-
7800	6/12	53.6	7300	35 °C / 35 %	19	16	7.65
	6	57			18.5	90	-

Technical data of electric heaters (supply power 3x 400V / 50Hz, 1x 230V / 50Hz), assignment of control kits

Size unit	type DI	power [kW]	no. of sections	Digireg®
500	IBE-DUOVENT DV 500_2/1	2	1	M1-E2
800	IBE-DUOVENT DV 800_3,6/1	3.6	1	M1-E8-2
1200	IBE-DUOVENT DV 1200_3,6/1	3.6	1	M1-E8-2
1800	IBE-DUOVENT DV 1800_7,5/1	7.5	1	M3-E8-2
3000	IBE-DUOVENT DV 3000_15/1	15	1	M3-E15
4200	IBE-DUOVENT DV 4200_15/1	15	1	M3-E15
5100	IBE-DUOVENT DV 5100_22,5/1	22.5	1	M3-E24
6000	IBE-DUOVENT DV 6000_22,5/1	22.5	1	M3-E24
6900	IBE-DUOVENT DV 6900_30/1	30	1	M3-E36
7800	IBE-DUOVENT DV 7800_30/1	30	1	M3-E36

Optionally, the unit can be ordered with atypical powers of electric heaters For this variant contact our technical dept.

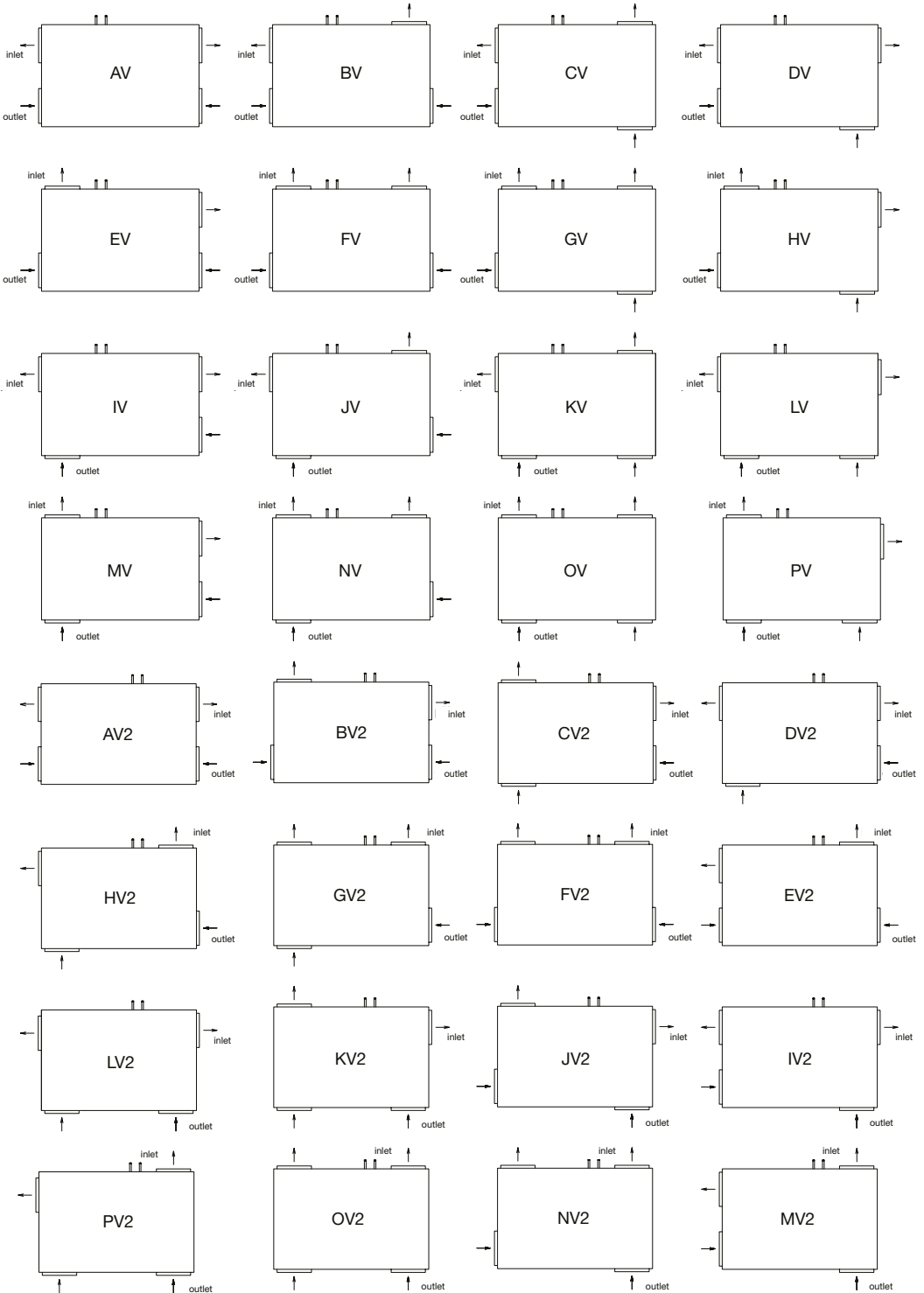
Neck variants – vertical arrangement (viewed from unit operation side)

Neck variants – horizontal arrangement (viewed from upper non-operation side of the unit, floor plan)

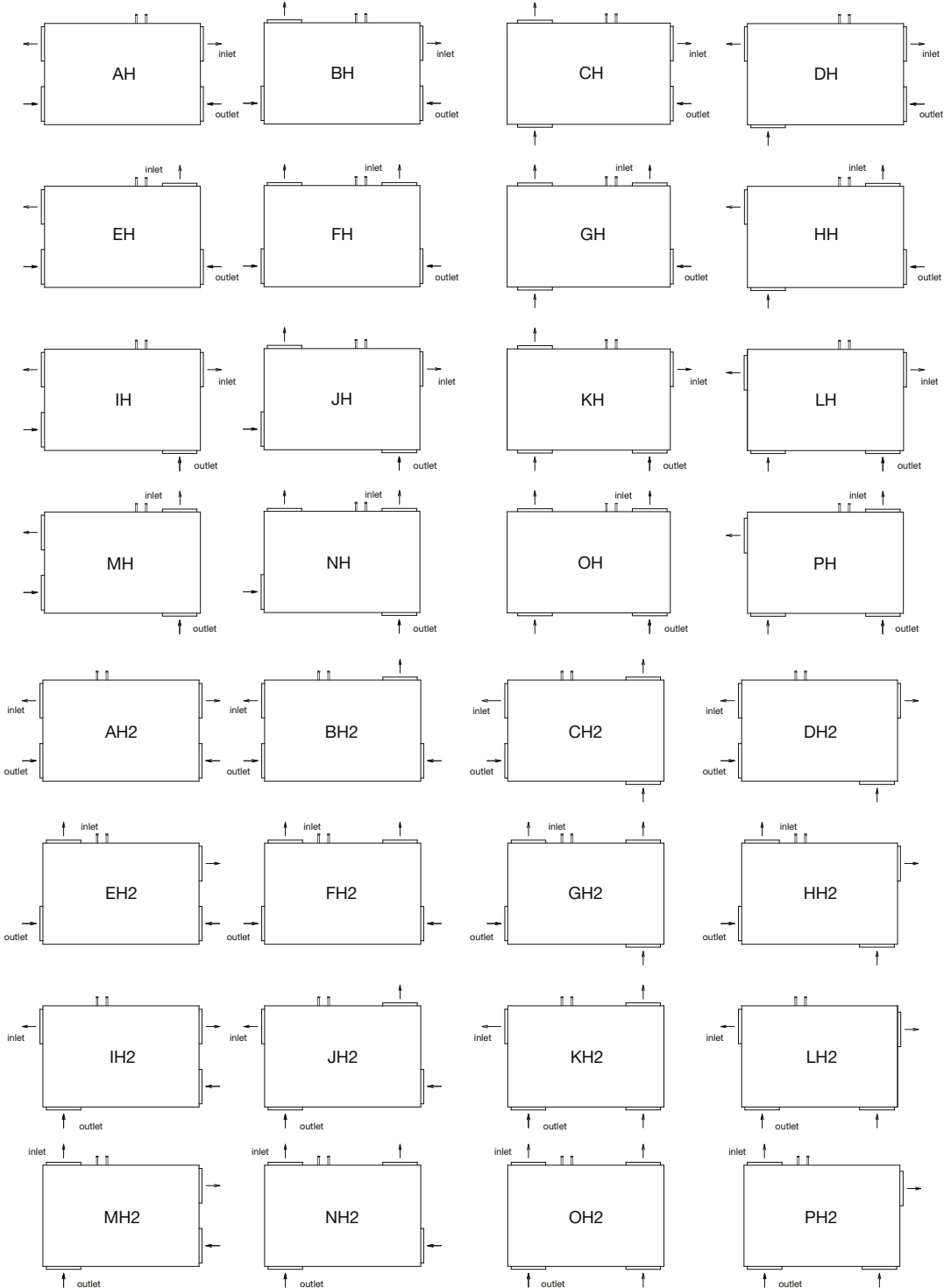

Recuperation

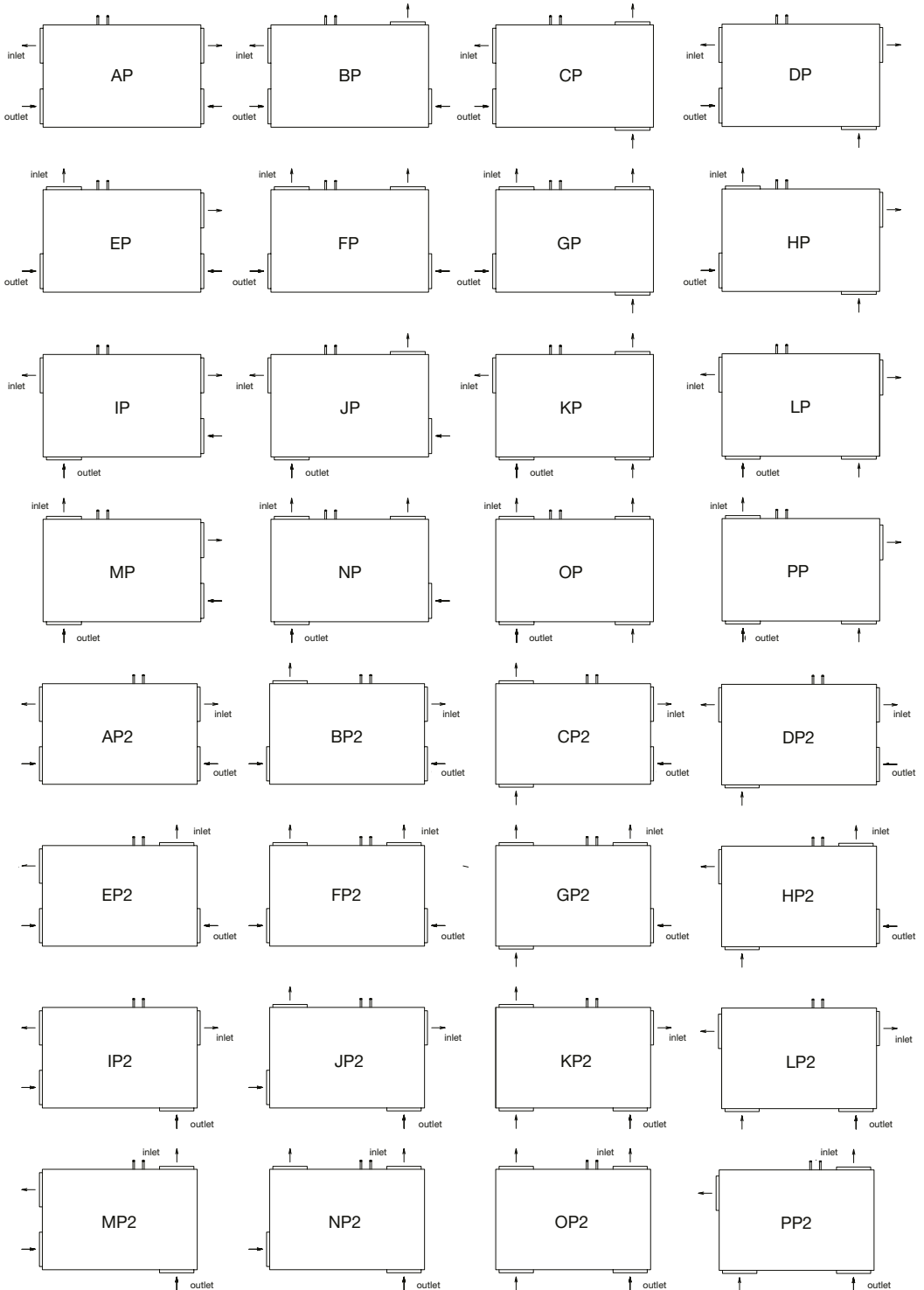
Neck variants – floor horizontal arrangement (viewed from upper operation side of the unit)

DUO-DV-IAE

- Flexible coupling to connect inlet and outlet necks of HVAC unit with pipe lines
- Prevents transfer of vibration to air-ducts
- Flange width 20 mm
- To be delivered for unit sizes DV 1800–7800
- For unit sizes DV 500, 800, 1200 it is possible to deliver standard accessory KAA 200, KAA 250, KAA 315.

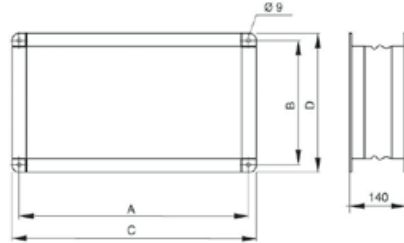

Variant of flexible couplings for upper and side unit outlets (SUP or EHA):

Type	A [mm]	B [mm]	C [mm]	D [mm]
DUO-DV-IAE-1800	320	620	340	640
DUO-DV-IAE-3000	470	620	490	640
DUO-DV-IAE-4200	650	620	670	640
DUO-DV-IAE-5100	820	620	840	640
DUO-DV-IAE-6000	970	620	990	640
DUO-DV-IAE-6900	1120	620	1140	640
DUO-DV-IAE-7800	1270	620	1290	640

Type	A [mm]	B [mm]	C [mm]	D [mm]
DUO-DV-IAE-1800-BV	320	370	340	390
DUO-DV-IAE-3000-BV	470	370	490	390
DUO-DV-IAE-4200-BV	650	420	670	440
DUO-DV-IAE-5100-BV	820	420	840	440
DUO-DV-IAE-6000-BV	970	420	990	440
DUO-DV-IAE-6900-BV	1120	420	1140	440
DUO-DV-IAE-7800-BV	1270	420	1290	440

DUO-DV-PRO

- Transition piece for round piping
- at outlets of unit sizes DV 1800–7800
- Flange width 20 mm

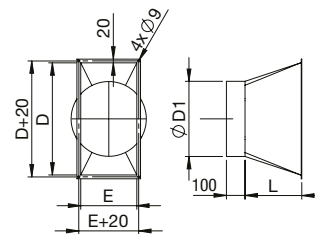

Variant of transition parts for upper and side unit outlets (SUP or EHA):

Type	D [mm]	D1 [mm]	E [mm]	L [mm]
DUO-DV-PRO-1800	600	397	300	300
DUO-DV-PRO-3000	600	557	450	350
DUO-DV-PRO-4200	600	627	630	400
DUO-DV-PRO-5100	600	707	800	450
DUO-DV-PRO-6000	600	797	950	500
DUO-DV-PRO-6900	600	797	1100	500
DUO-DV-PRO-7800	600	797	1250	500

Type	D [mm]	D1 [mm]	E [mm]	L [mm]
DUO-DV-PRO-1800-BV	350	397	300	300
DUO-DV-PRO-3000-BV	350	557	450	350
DUO-DV-PRO-4200-BV	400	627	630	400
DUO-DV-PRO-5100-BV	400	707	800	450
DUO-DV-PRO-6000-BV	400	797	950	500
DUO-DV-PRO-6900-BV	400	797	1100	500
DUO-DV-PRO-7800-BV	400	797	1250	500

ROOFPACK – Roof variant of recuperation units

ROOFPACK-A

- for horizontal (floor) and vertical unit variant
- Roof from galvanized steel or painted sheet
- Direct installation to the unit
- Walkable middle part of the roof to facilitate service access for the unit horizontal variant
- Frame height 150mm in combination with feet
- Insulated corner profiles of cabinet frame
- Watertight variant of external case
- With unit vertical variant, this type of accessory can be delivered for following positions of the outlet necks only: AV, DV, IV, LV, AV2, DV2, IV2, LV2
- With unit horizontal variant, this type of accessory can be delivered for all possible neck positions: AP to PP, AP2 to PP2
- **For unit inlet part the electric heaters IBET of power 250W or 1000W can be delivered as an accessory. The heater will prevent freezing of the water exchangers with the unit shut-down. The heater is controlled independently by integrated thermostat.**

Type key for ordering of ROOFPACK accessory



- 1 – ROOFPACK accessory type:
ROOFPACK – A
ROOFPACK – B
- 2 – Identification of recuperation unit type:
DUO-DV = DUOVENT® COMPACT DV
- 3 – unit position:
V – vertical
H – horizontal (floor)
- 4 – unit size Duovent® Compact DV:
500, 800, 1200, 1800, 3000, 4200, 5100, 6000, 6900, 7800

Recuperation

Vertical variant ROOFPACK-A

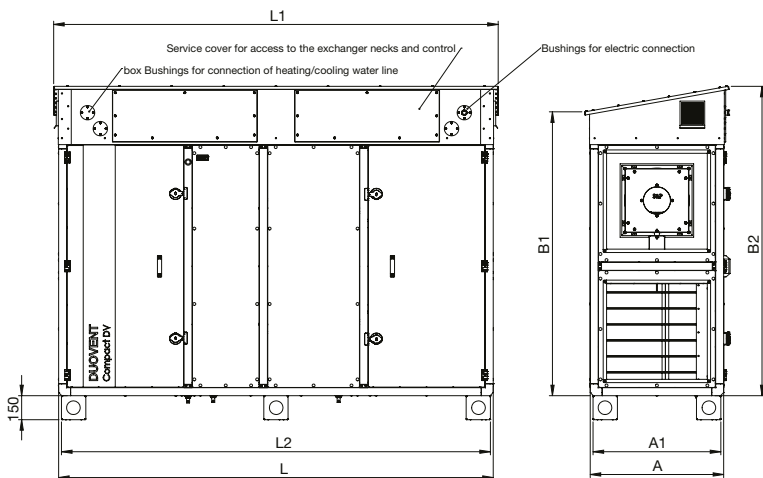

Size unit	L [mm]	L1 [mm]	L2 [mm]	A [mm]	A1 [mm]	B1 [mm]	B2 [mm]	weight [kg]
500	1698	1760	1662	364	328	834	994	26
800	1934	1996	1898	364	328	1148	1308	32
1200	2091	2153	2055	521	485	1148	1308	42
1800	2562	2624	2526	521	485	1776	1936	61
3000	2562	2624	2526	678	642	1776	1936	69
4200	2719	2781	2683	835	799	1776	1936	77
5100	2719	2781	2683	992	956	1776	1936	85
6000	2719	2781	2683	1149	1113	1776	1936	93
6900	2719	2781	2683	1306	1270	1776	1936	102
7800	2719	2781	2683	1463	1427	1776	1936	110

ROOFPACK – Roof variant of recuperation units

Horizontal variant ROOFPACK-A

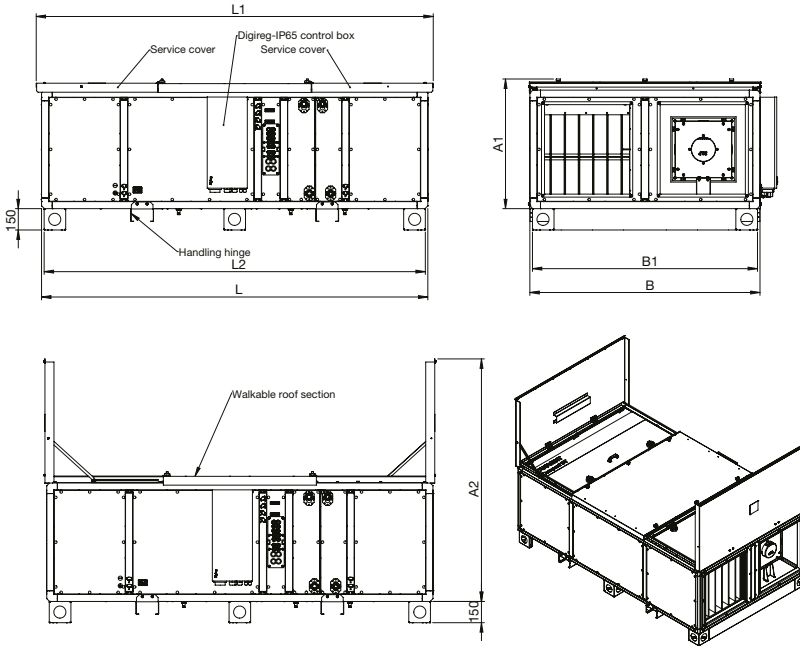

Size unit	L [mm]	L1 [mm]	L2 [mm]	A1 [mm]	A2 [mm]	B [mm]	B1 [mm]	weight [kg]
500	1698	1774	1662	442	1080	678	642	23
800	1934	2010	1898	442	1237	992	956	35
1200	2091	2167	2055	599	1394	992	956	45
1800	2562	2638	2526	599	1394	1620	1584	72
3000	2562	2638	2526	756	1551	1620	1584	72
4200	2719	2795	2683	913	1708	1620	1584	86
5100	2719	2795	2683	1070	1865	1620	1584	86
6000	2719	2795	2683	1227	2022	1620	1584	86
6900	2719	2795	2683	1384	2179	1620	1584	86
7800	2719	2795	2683	1541	2336	1620	1584	86

Arrangement examples of ROOFPACK-A for the unit vertical and horizontal variants



DUOVENT® COMPACT DV 4200 + ROOFPACK-A



DUOVENT® COMPACT DV 4200 + ROOFPACK-A

ROOFPACK – Roof variant of recuperation units

ROOFPACK-B

- for horizontal (floor) and vertical unit variant
- Roof from galvanized steel or painted sheet
- Direct installation to the unit
- Walkable middle part of the roof to facilitate service access for the unit horizontal variant
- frame of height 350 mm for integration to the roof structure, the frame is demountable with inner insulation of thickness 30 mm and at lower part it is fitted with holes Ø12 mm to insert the anchor bolts M10 to the roof structure
- Insulated corner profiles of cabinet frame
- Watertight variant of external case

- With unit vertical variant, this type of accessory can be delivered for following positions of the outlet necks only: AV, AV2
- With unit horizontal variant, this type of accessory can be delivered for all possible neck positions: AP to PP, AP2 to PP2
- For unit inlet part the electric heaters IBET of power 250W or 1000W can be delivered as an accessory. The heater will prevent freezing of the water exchangers with the unit shut-down. The heater is controlled independently by integrated thermostat.

Type key for ordering of ROOFPACK accessory

ROOFPACK - B - DUO - DV - V - 3000

1 2 3 4

- 1 – ROOFPACK accessory type:
ROOFPACK – A
ROOFPACK – B
- 2 – Identification of recuperation unit type:
DUO-DV = DUOVENT® COMPACT DV
- 3 – unit position:
V – vertical
H – horizontal (floor)
- 4 – unit size DUOVENT®
COMPACT DV: 500, 800, 1200, 1800, 3000, 4200, 5100, 6000, 6900, 7800

Vertical variant ROOFPACK-B

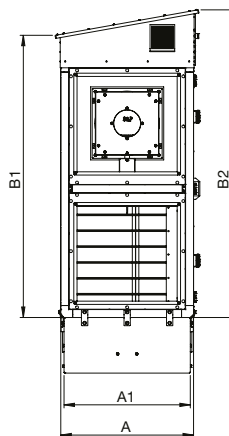
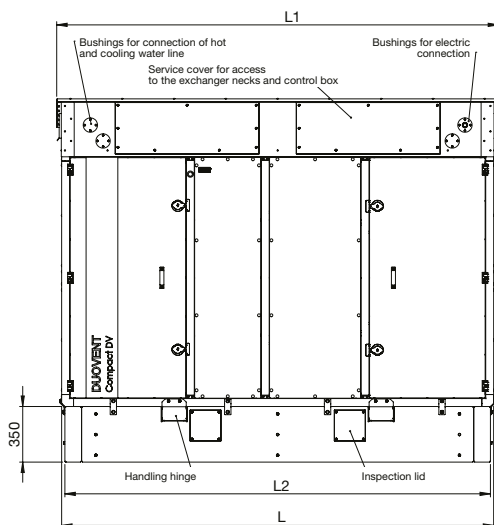

Size unit	L [mm]	L1 [mm]	L2 [mm]	A [mm]	A1 [mm]	B1 [mm]	B2 [mm]	weight [kg]
500	1698	1760	1658	364	324	834	994	61
800	1934	1996	1894	364	324	1148	1308	73
1200	2091	2153	2051	521	481	1148	1308	102
1800	2562	2624	2522	521	481	1776	1936	141
3000	2562	2624	2522	678	638	1776	1936	153
4200	2719	2781	2679	835	795	1776	1936	167
5100	2719	2781	2679	992	952	1776	1936	182
6000	2719	2781	2679	1149	1109	1776	1936	194
6900	2719	2781	2679	1306	1266	1776	1936	207
7800	2719	2781	2679	1463	1423	1776	1936	219

ROOFPACK – Roof variant of recuperation units

Horizontal variant ROOFPACK-B

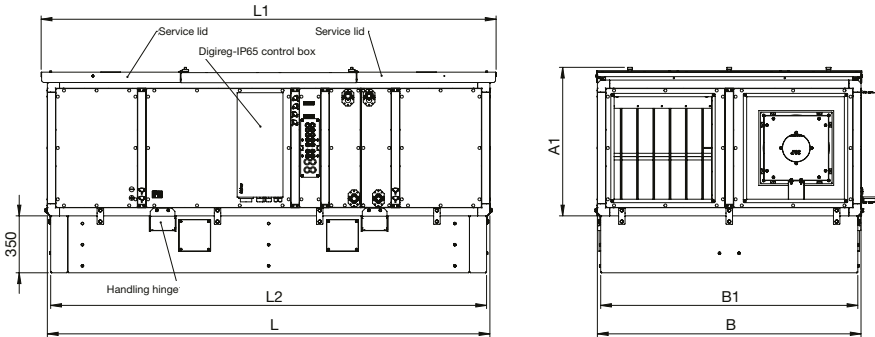

Size unit	L [mm]	L1 [mm]	L2 [mm]	A1 [mm]	A2 [mm]	B [mm]	B1 [mm]	weight [kg]
500	1698	1774	1658	442	1080	678	638	77
800	1934	2010	1894	442	1237	992	952	107
1200	2091	2167	2051	599	1394	992	952	117
1800	2562	2638	2522	599	1394	1620	1580	187
3000	2562	2638	2522	756	1551	1620	1580	187
4200	2719	2795	2679	913	1708	1620	1580	204
5100	2719	2795	2679	1070	1865	1620	1580	204
6000	2719	2795	2679	1227	2022	1620	1580	204
6900	2719	2795	2679	1384	2179	1620	1580	204
7800	2719	2795	2679	1541	2336	1620	1580	204

Arrangement examples of ROOFPACK-B for the unit vertical and horizontal variant

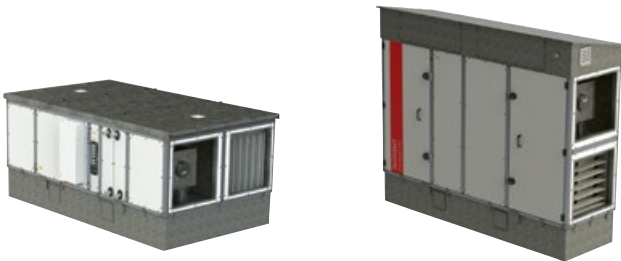

DUOVENT® COMPACT DV 4200 + ROOFPACK-B

DUOVENT® COMPACT DV 4200 + ROOFPACK-B

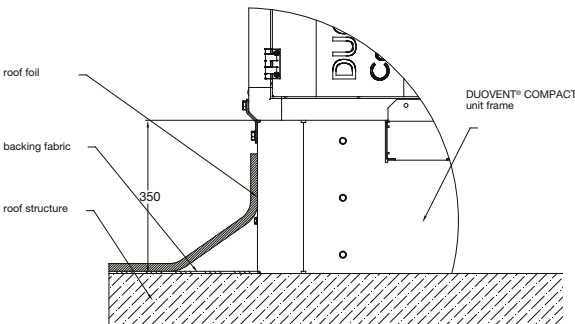

Example of integration of the support frame ROOFPACK-B to the building roof structure

DUO-DV-MOUNT – Rain louvres

DUO-DV-MOUNT

- The rain louvres for outdoor use of the unit
- Made from galvanized steel sheet
- Fitted with anti-bird meshes
- Optionally delivered with dust coat spraying of external view louvre surfaces
- To be delivered for unit sizes DV 1800–7800
- For the unit sizes DV 500, 800, 1200 it is possible to deliver standard accessory VKS 200, VKS 250, VKS 315 in combination with connecting neck SN 200, SN 250, SN 315 and single-blade sealing

Type key for ordering of accessories DUO-DV-MOUNT

DUO - DV - V - MOUNT 3 0 0 0 I N

- 1 – unit size
 V – vertical
 H – horizontal (floor)
- 2 – unit size DUOVENT® COMPACT DV
 1800, 3000, 4200, 5100, 6000, 6900, 7800
- 3 – Accessory type
 IN – for suction
 OUT – for outlet

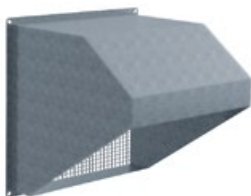

outlet

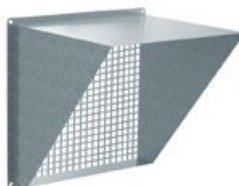

outlet

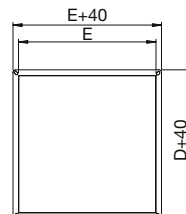
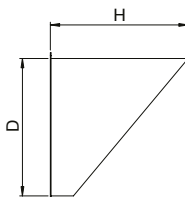
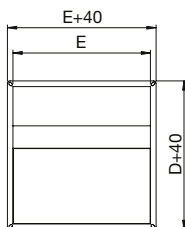
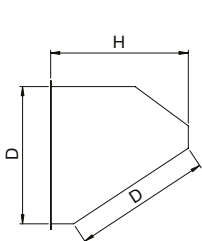

DUO-DV-MOUNT – Rain louvres

Louvres for unit suction

Type	D [mm]	E [mm]	H [mm]
DUO-DV-V-MOUNT 1800 IN	600	300	600
DUO-DV-V-MOUNT 3000 IN	600	450	600
DUO-DV-V-MOUNT 4200 IN	600	630	600
DUO-DV-V-MOUNT 5100 IN	600	800	600
DUO-DV-V-MOUNT 6000 IN	600	950	600
DUO-DV-V-MOUNT 6900 IN	600	1100	600
DUO-DV-V-MOUNT 7800 IN	600	1250	600

Type	D [mm]	E [mm]	H [mm]
DUO-DV-H-MOUNT 1800 IN	300	600	300
DUO-DV-H-MOUNT 3000 IN	450	600	450
DUO-DV-H-MOUNT 4200 IN	630	600	630
DUO-DV-H-MOUNT 5100 IN	800	600	800
DUO-DV-H-MOUNT 6000 IN	950	600	950
DUO-DV-H-MOUNT 6900 IN	1100	600	1100
DUO-DV-H-MOUNT 7800 IN	1250	600	1250

Louvres for unit outlet

Type	D [mm]	E [mm]	H [mm]
DUO-DV-V-MOUNT 1800 OUT	600	300	600
DUO-DV-V-MOUNT 3000 OUT	600	450	600
DUO-DV-V-MOUNT 4200 OUT	600	630	600
DUO-DV-V-MOUNT 5100 OUT	600	800	600
DUO-DV-V-MOUNT 6000 OUT	600	950	600
DUO-DV-V-MOUNT 6900 OUT	600	1100	600
DUO-DV-V-MOUNT 7800 OUT	600	1250	600

Type	D [mm]	E [mm]	H [mm]
DUO-DV-H-MOUNT 1800 OUT	300	600	300
DUO-DV-H-MOUNT 3000 OUT	450	600	450
DUO-DV-H-MOUNT 4200 OUT	630	600	630
DUO-DV-H-MOUNT 5100 OUT	800	600	800
DUO-DV-H-MOUNT 6000 OUT	950	600	950
DUO-DV-H-MOUNT 6900 OUT	1100	600	1100
DUO-DV-H-MOUNT 7800 OUT	1250	600	1250

Variant of rain louvres for unit side outlets (for horizontal floor variant – outlets SUP or EHA):

Type	D [mm]	E [mm]	H [mm]
DUO-DV-H-MOUNT 1800 IN-BV	300	350	300
DUO-DV-H-MOUNT 3000 IN-BV	450	350	450
DUO-DV-H-MOUNT 4200 IN-BV	630	400	630
DUO-DV-H-MOUNT 5100 IN-BV	800	400	800
DUO-DV-H-MOUNT 6000 IN-BV	950	400	950
DUO-DV-H-MOUNT 6900 IN-BV	1100	400	1100
DUO-DV-H-MOUNT 7800 IN-BV	1250	400	1250

Type	D [mm]	E [mm]	H [mm]
DUO-DV-H-MOUNT 1800 OUT-BV	300	350	300
DUO-DV-H-MOUNT 3000 OUT-BV	450	350	450
DUO-DV-H-MOUNT 4200 OUT-BV	630	400	630
DUO-DV-H-MOUNT 5100 OUT-BV	800	400	800
DUO-DV-H-MOUNT 6000 OUT-BV	950	400	950
DUO-DV-H-MOUNT 6900 OUT-BV	1100	400	1100
DUO-DV-H-MOUNT 7800 OUT-BV	1250	400	1250